

10. COMPLEX RESISTIVITY & HACSAMT PROGRAM

10.1	INTRODUCTION.....	2
10.2	CR PROGRAM OPERATION.....	3
10.3	GATHERING DATA.....	10
10.4	A NOTE ON PHASE	16
10.5	A NOTE ON SCALING	16
10.6	3-POINT DECOUPLING.....	17
10.7	SAMPLE DATA BLOCKS	18
10.8	NOTES ON FIELD CONFIGURATIONS.....	20
10.9	SAMPLE MENUS FOR "LABROX" OPTION.....	21
10.10	SAMPLE MENUS FOR "HACSAMT" OPTION	24
10.11	FIELD CONFIGURATIONS.....	26
	GDP SETUP: RESISTIVITY, TDIP, RPIP, NR CR	26
	GDP SETUP WITH ROLL-ALONG CABLE: RESISTIVITY, TDIP, RPIP, NR CR	27
	TRANSMITTER SETUP: TDIP, RPIP, NON-REFERENCE CR.....	28
	TRANSMITTER SETUP WITH CURRENT REFERENCE	29
	COMPLEX RESISTIVITY RECEIVER SETUP WITH CURRENT REFERENCE	30
	FULL REFERENCE CALIBRATION	31
	LABORATORY ROCK MEASUREMENT SETUP.....	32
	ALTERNATE LABORATORY ROCK MEASUREMENT SETUP	33

10.1 INTRODUCTION

This Fourier transform based program forms the basic complex resistivity (CR) program for field and laboratory multifrequency IP measurements, and can also be used for harmonic CSAMT, frequency EM, MMR, and other programs using magnetic field sensors. This is an enhanced program using synchronous stacking and averaging, in addition to Fourier transform methods to improve the signal to noise ratio.

The frequency range of the CR program is from 0.015625 to 9216 Hz. Complex resistivity (IP) measurements are commonly made using the fundamental frequencies of 0.125, 1.0, and 8 Hz to acquire magnitude and phase information from 0.125 to 72 Hz.

Access to the analog board calibrate buffer is labeled **5) CR CALIBRATE** in the **ACCESS CACHE**.

The operator can choose channel designations of Ex, Ey, Ez, Hx, Hy, Hz, and Ref (for current referenced CR). If a magnetic channel is specified, (Hx, Hy, Hz), the program will deconvolve the measured results with the contents of the calibrate buffer in the ACCESS CACHE labeled **6) CR ANTENNA CAL**. This permits the user to incorporate the calibration values of the magnetic sensors being used. The program has an HACSAMT (harmonic CSAMT) option as well as provision for FEM and MMR measurements using the HACALS calibration buffer.

The program has a digital telluric filter, which we call a moving average or MAV filter, for rejection of low frequency tellurics. This filter is installed for frequencies from 0.015625 to 1.0 Hz.

This manual is written in generic form for eight channels. If your receiver has more or less than eight channels, only information for the number of channels contained will be displayed.

Go to **Section 6** of the receiver instruction manual for information concerning calibration, synchronization and generic operation of all programs.

Go to the end of this CR program manual for suggestions on connecting the receiver for field measurements.

10.2 CR PROGRAM OPERATION

MENU 1:

In all of the following menu descriptions, the bold fields in the boxes are the parameters that can be changed by the operator.

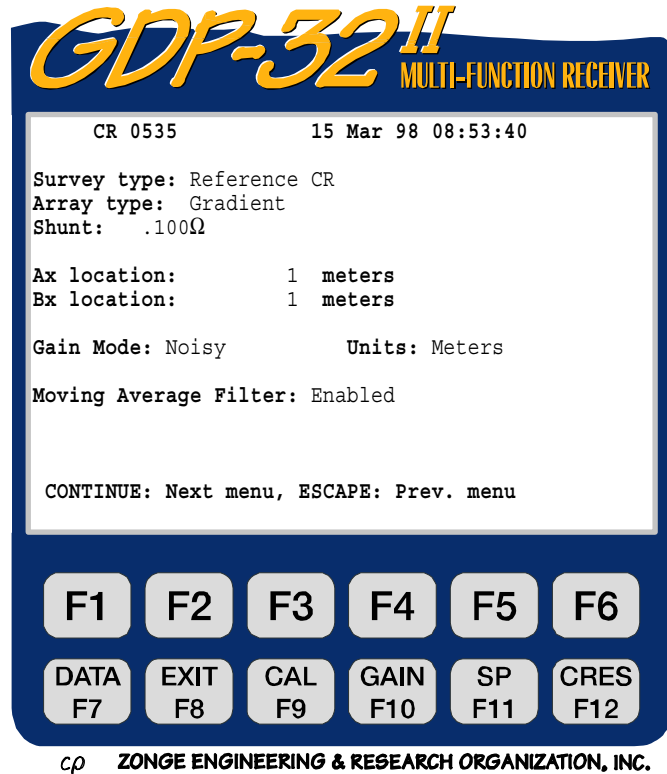

The **DATA** function key is active.

CR 0535. Program name and version.

15 Mar 98. Date.

08:53:40. Time.

Survey type. Five identifiers are available here:

Non-reference CR - Using the Fourier transform technique in the standard RPIP mode without a reference channel connected to monitor the transmitter current.

Reference CR - complex resistivity using the **Ref** channel identifier in the channel setup. The Ref channel is then connected to the transmitter current monitor.

HA CSAMT - Harmonic CSAMT option. Acquires and calculates resistivities just as the single frequency CSAMT program.



Continuous - loads an experimental program developed for continuous logging in downhole or underwater applications. Once started, the program will continue to acquire data continuously, in bursts specified by the number of cycles in Menu 4, until the



key is pressed.

LABROX - Program for measuring core samples in the laboratory. Takes into account the size of the core sample for resistivity calculations.

We will use the Reference CR mode as the example of how to set up the receiver with the various menus in the following pages.

Array type. Six types of arrays are selectable with the  or  keys:

Dipole-Dipole	D-D
Pole-Dipole	P-D
Schlumberger	Sch
Gradient	Grd
Pole-Pole	P-P
Downhole	D-H
Core Sample	LAB

When the **HACSAMT** option is chosen, the following array type is set automatically:

Harmonic CSAMT **AMT**

If Gradient or Schlumberger arrays are chosen, then the additional two lines **Ax location** and **Bx location** appear in the menu. These are the transmitter current electrode locations.

If the downhole array type is chosen, resistivities will not be calculated or displayed.

Shunt. The value of the current sense resistor must be input here in order for the CR program to calculate the output current of the transmitter when using the **REF** channel. Values of current sense (shunt) resistors for standard GGT-series transmitters and the laboratory setup are as follows:

GGT-2.5, GGT-3	0.100 Ω
GGT-5, GGT-6, GGT-10	0.100 Ω
GGT-20, GGT-25, GGT-30	0.050 Ω
ZT-30 / ZT-20	0.100 Ω
NT-20	1.000 Ω
LABROX	0.100 K Ω to 9999 K Ω



NOTE: The **Shunt** prompt is not displayed for the non-reference CR mode.

Gain Mode. The default mode is "Noisy", which limits the gains to obtain a maximum voltage of 1.0 Volts, leaving lots of headroom for SP drift and random noise spikes. The other option is "Standard", which adjusts the gains for a maximum voltage of 2.25 Volts. See **Section 6**.

Units. The operator can select meters or feet. The default is meters.

Moving Average Filter. This is a telluric filter used for the frequency range of 0.015625 to 1.0 Hz. The default mode is **Enabled**, but the filter can be **Disabled** for research applications.

MENU 2:

The  function key is active. By pressing the  function key you can temporarily exit the data taking routine and look at data in the field data cache. See *Section 7 GDP* for more details.

OPER. User defined identification number. Alphanumerics are permitted.

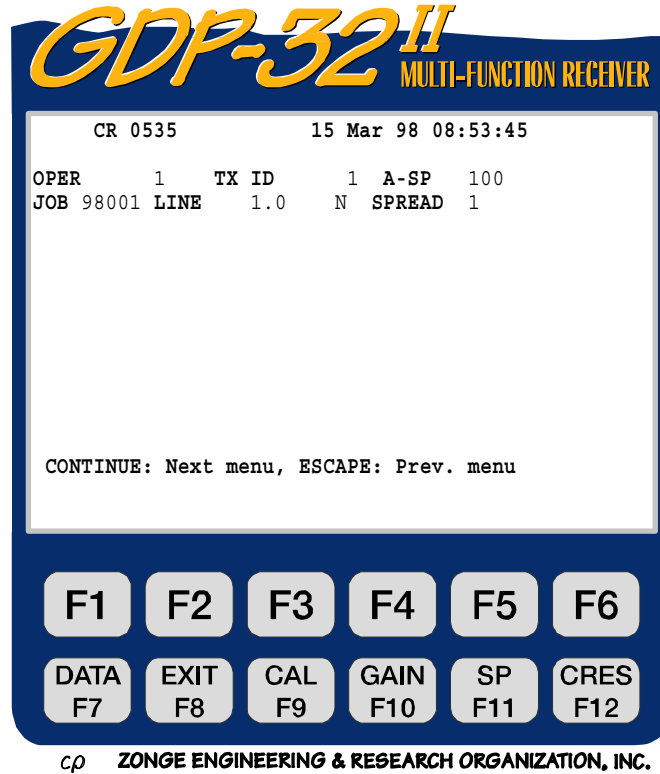

TX ID. User defined identification number. Alphanumerics are permitted.



A-SP. Dipole size (A-spacing) in feet or meters, as selected in the previous menu.

JOB. User defined identification number. Alphanumerics permitted.

LINE. Two fields available: **xxxxx.x** defines the line number and **N, E, S, W,**

NE, SE, SW, NW designators are available by using the  and  keys. Alphanumerics are permitted for the line number.

SPREAD. User defined identification number, subdivision of the **LINE** designator above. Alphanumerics are permitted.

MENU 3: The following example is the setup for a 6-channel (N = 1 through N = 6) CR survey.

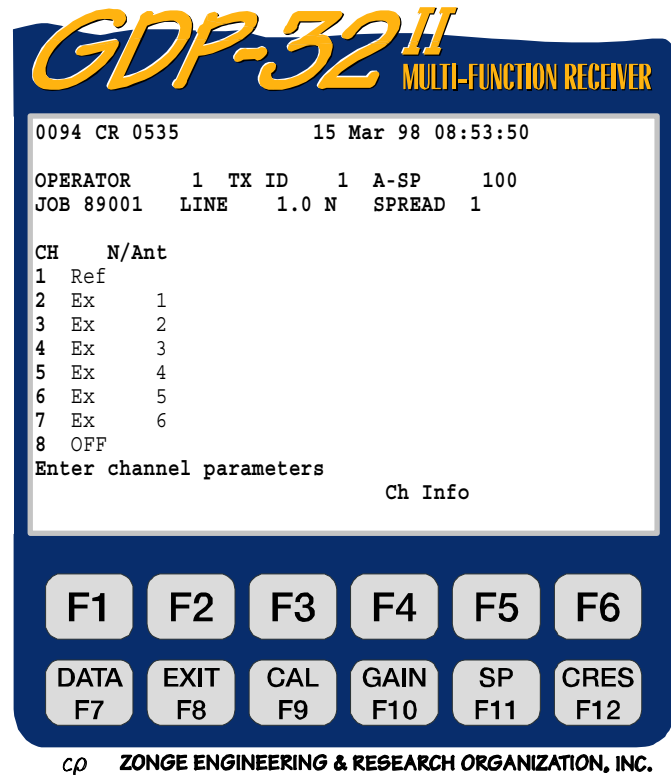

**DATA
F7**

The function key is active.

CH. Any channel designator other than **OFF** will turn a channel on. **Ref** designates the transmitter current reference input channel for CR measurements.

N/Ant. Dual usage field:

- 1) Defines N-spacing (includes fractionals) for a channel designated as E_x, E_y, or E_z.
- 2) H-field designator: Used to identify the magnetic field sensor used for that channel. The number in this field must have an exact matching number in the **CR ANTENNA CAL** calibrate cache. Used for HACSAMT, Frequency EM, MMR, MIP, etc.

F5

Ch Info. By pressing , you can access information for the analog cards that have been turned on. For example:

```
1 DiffAmp Notch+60,3-50,3 S/N 67 Passed 1.00192
2 DiffAmp Notch+60,3-50,3 S/N 127 Passed 0.99835
3 DiffAmp Notch+60,3-50,3 S/N 256 Passed 0.99786
```

etc.

Where **DiffAmp** indicates the input plug-in device is a differential amplifier, the powerline notch filter is a **60/180 and 50/150 Hz** filter, and the board serial numbers are **67, 127, 256**, etc.

Note: In Menus 3 and 4 a number (**0094**) is visible before the program designator (**CR 0535**). This number is the label of the last data block written to the data cache. The next time a block of data is written to the cache, it will be numbered **0095**.

MENU 4



Upon pressing  after the parameters are set up in Menu 3 the following screen will be displayed. This is a combination of Menu 3 and Menu 4.

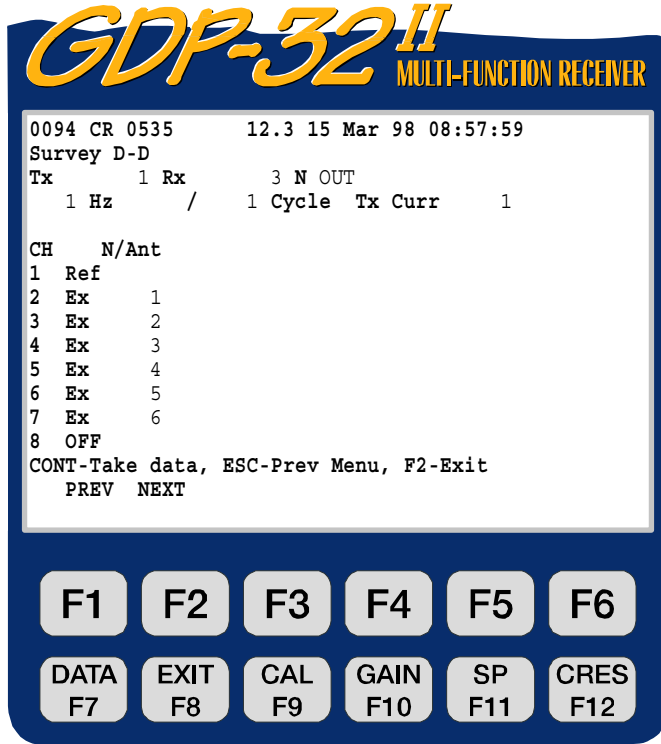

← We have selected the Dipole-Dipole reference CR mode

Soft function keys





and

are active.

© ZONGE ENGINEERING & RESEARCH ORGANIZATION, INC.

PREV/NEXT

Pressing  and  permits the operator to scroll the channel parameters up and down, so that all 16 channels can be accessed. These labels will not be displayed if the receiver has 8 channels or less.

All function keys are active:





Tx. Transmitter location. Our convention is to use the lowest numbered electrode of the dipole (or the electrode for a transmitting pole). Here we are transmitting on a dipole with electrodes numbered 1 and 2. Hence, Tx is set to 1. The field for Tx designation is **+NNNNNNN** with a floating decimal point.

Note: for the Gradient array selection, "Tx" will appear as "Ry", and is used to input the receiver coordinates. See the TDIP or RPIP program manual for examples.

Rx. Receiver location. Our convention is to use the lowest numbered electrode for the dipole closest to the transmitting dipole (or pole). Here we are receiving on dipoles 3,4; 4,5; etc. Hence, Rx is set to 3. See **Section 15** for other arrays. The field for Rx designation is **+NNNNNNN** with a floating decimal point.

N OUT. Powerline notch filter switch. You have two or three possible selections here, depending upon the configuration of your receiver. For this example, we have three options



since we have both 50 and 60 Hz notch filters installed. Use  or  to change.

- OUT** - All notch filters bypassed.
- 60** - 60 and 180 Hz notch filters enabled.
- 50** - 50 and 150 Hz notch filters enabled.
- 50/60**- 50, 150, 60 and 180 Hz notch filters enabled

Standard selections for all 50 Hz or all 60 Hz filters are:

- 50,5** - 50, 150, 250 and 450 Hz notch filters enabled.
- 60,5** - 60, 180, 300 and 540 Hz notch filters enabled.

Hz. Frequency selection - use  or  to change.

Cycle. Specify the number of cycles to average. Increments are in binary steps. Use  or  to change. As the system acquires data, the cycles count will be updated in real-time to the left of the number input by the operator.

Tx Curr. Transmitter current. The current value must be entered manually if the **Ref** channel is not used. With the **Ref** channel enabled, the actual value of the current is calculated by the receiver and entered into this field automatically. The calculated current is the square-wave equivalent current - i.e. what the operator would read off of the display on the transmitter.

N/Ant. Defines N-spacing (includes fractionals) for a channel designated as E_x, E_y, or E_z. This parameter can be accessed in both menus 3 and 4 for ease in changing values during a survey. This field also defines antenna calibrate cache labels for channels designated as H_x, H_y, or H_z, for removing antenna calibrates in HACSAMT, Frequency EM, MMR or other types of magnetic field surveys. The **Ant** designators can be changed in Menu 3 only, and the **Ant** designators must match the numbers in the HACALS calibrate buffer for the calibrates to be removed.

DATA
F7

Press this key to temporarily exit the data taking routine and look at data in the field data cache. See **Section 7.2** for more details.

EXIT
F8

Exit the data taking routine and return to the main menu for selection of other programs. When exiting the program at this point, the main menu will display **Back**

above the  key to enable the operator to return to the CR program, if desired

CAL
F9

Press this key to enter the calibrate and system checking program. See **Section 6.1** for more details.

GAIN
F10

Press this key to enter the automatic or manual gain setting and SP buckout routines. See **Section 6.5** for more details.

SP
F11

Pressing this key will automatically buck out any self-potential (SP) or amplifier offset, for any channel that is turned on.

CRES
F12

Press this key to enter the contact resistance measuring routine. See **Section 6.3** for more details.

NOTE:

F5

is used to change the displayed phase between raw and 3-point decoupled. If the



label above the key is **RAW** ϕ , pushing **F5** will cause the raw phase to be displayed. If

the label is **3PT** ϕ , pushing **F5** will cause the 3-point decoupled phase to be displayed.

F5

is labeled **L/A** for the **LABROX** option. By pressing this key the operator can input the length and cross sectional area of the rock sample and adjust the shunt resistance used for monitoring current.

***NOTE:** Some values are not registered in the computer memory until you exit the parameter*

*field by pressing  ,  , or  . An exception to this rule is the **Hz** (frequency) field. Whenever you change the frequency it is automatically changed through the timing card. However, the anti-alias filter is not changed until just prior to data acquisition. Upon pressing continue to gather data, the computer will automatically set the anti-alias filter as defined by internal look-up tables.*

*Notice also that the battery voltage (**12.3**) is displayed between the program version number and the date.*

10.3 GATHERING DATA



Upon pressing **CONTINUE** after the parameters are set up in Menu 4 the following screen display is an example of what you will see with a signal connected to channels 1 through 7. The battery voltage is measured and the A/D converter is automatically calibrated before each measurement cycle.

For this example we will set the frequency to 0.125 Hz, set the number of cycles to acquire to 4, and leave the rest of the parameters alone. The signal source is an LDT/10 laboratory transmitter with an RC load, and the gains are automatically set. Channels 1 through 7 are connected across the RC load.

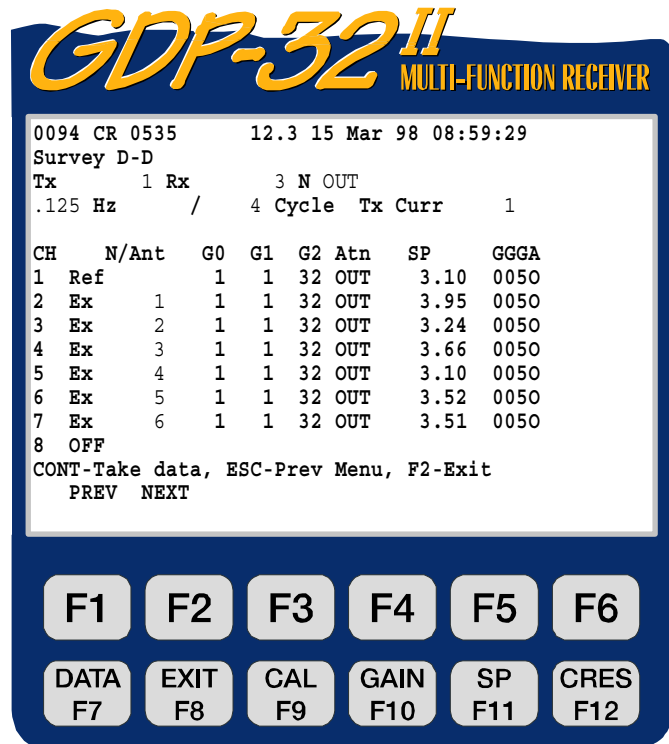

cp ZONGE ENGINEERING & RESEARCH ORGANIZATION, INC.

The program will first set up the gains, buck out the SP automatically and then continue to gather data. Since we are operating in the default "noisy" gain mode, all of the necessary gain is put into **G2** first. (See **Section 6** for additional information). If you want to pause between gain setting and data gathering,



press .



The display is self explanatory, but the following comments will elaborate on some of the details.

G0, G1, G2. Gain stages 0, 1 and 2. The first two gain stages are set for unity gain and the third for a gain of 32.

Atn. The attenuator is bypassed (set to **OUT**). The other option is **IN**.

SP. The values of SP that has been bucked out is approximately 3 mv for all channels.

GGGA. Gain settings for stages 0, 1 and 2 (in powers of 2), and the attenuator setting **A**. For this example, gain stages 0 and 1 = $2^0 = 1$, gain stage 2 = $2^5 = 32$ and the attenuator is **OUT**.

Upon pressing  (Enter), the program will acquire four cycles of data for all enabled channels (unless the  (Escape) key is pressed before completion) and the results will look similar to the following for the real-time displays (while data are being acquired).

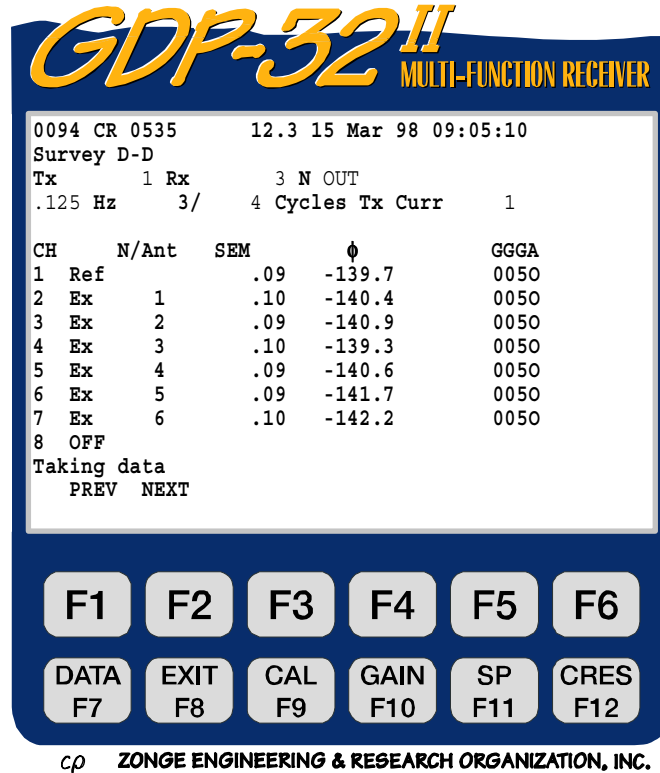

SEM. Standard error of the mean, in milliradians, calculated after each cycle, and based on the average phase.

ϕ . Average raw phase in milliradians.

After the selected number of cycles have been acquired (or  is pressed), the final display will appear as follows:

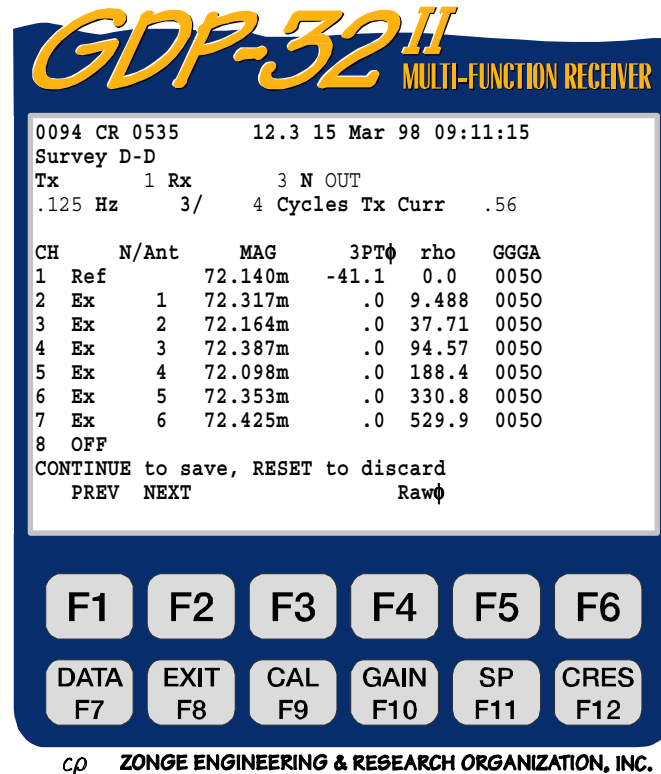



MAG. Magnitude of the received signal in volts, with the FFT magnitude calibrate (which is stored in the **CR CALIBRATE** cache) removed. The scaling factor "m" after the number means "millivolts". See the section towards the end of this manual on **SCALING** for more information.

3PTφ. 3-Point decoupled phase in milliradians, (default) for all channels except the Ref channel, with the FFT phase calibrate (which is stored in the **CR CALIBRATE** cache) removed.

rho. Apparent resistivity in ohm-meters.

RAWφ. By pressing  the operator can select to display either raw phase or 3-point



decoupled phase. If the phase column header reads **3PTφ**,  will be **RAWφ**. If raw

phase has been selected the phase column header will read **RAWφ** and the  selection will be **3PTφ**.

NOTES:

1. The **Tx Curr** has been changed to 0.56 amps, which was calculated from the voltage input on the **Ref** channel with a 0.1Ω shunt value. This current is the square-wave equivalent current or what the operator would read off of the transmitter current display.
2. For this example the phase shift for channels 2 through 7 is 0.0. This is due to the **Ref** channel being used to decalibrate channels 2 through 7. Notice that the decalibrated phase shift for channel 1 is -41 mr. This is the phase shift at 0.125 Hz for the RC circuit being used.
3. A resistivity value of 0.0 for the reference channel has no meaning since this channel is used for reference only.
4. When the machine displays the word "**Processing**" it is processing the FFT data and will display the results for all channels simultaneously when completed.



Upon pressing  to save the data (or  to discard the data), the screen will appear as follows, with the only difference in screens being the new block number (0095) and the bottom command line.

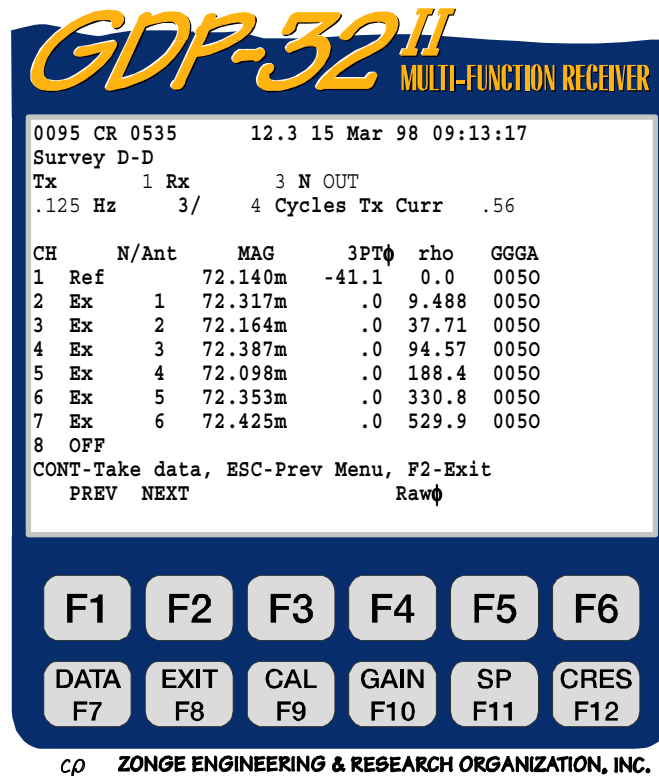

DATA
F7

To view all of the data, including the harmonic data, you must press the **DATA F7** function key. It will display the last stack taken and stored. See *Section 7* for explanations. The data display is in the following format:

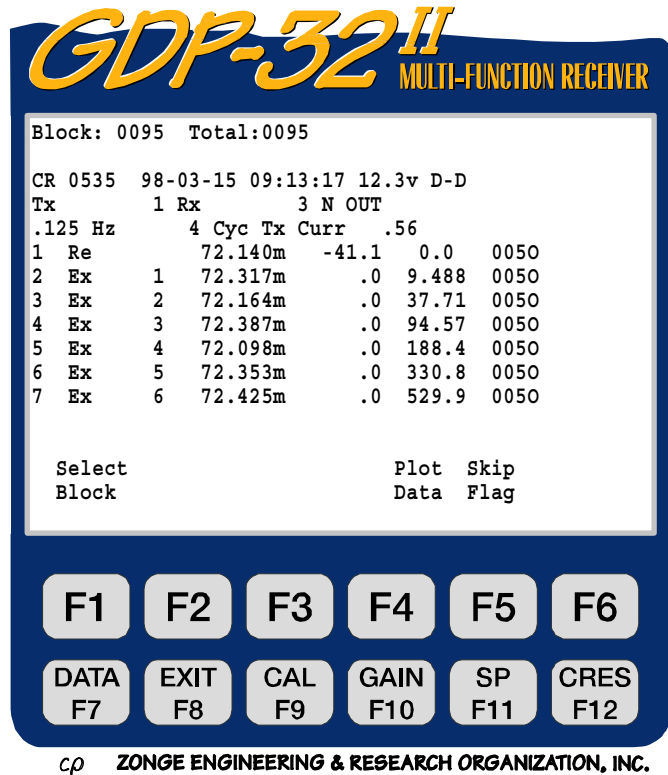

To view the harmonic data press

NEXT FIELD
Pg Dn

To return to the first part of the display

PREV FIELD
Pg Up

press

The values of the magnitudes and phase of the first through ninth harmonics for the 7 channels are saved but are off the screen to the right. The SEM, SP and contact resistance values have also been saved to the right of the screen.

To view these numbers, press



several times to move to the right,

or press

to move to the left.

F5

Plot Data. By pressing **F5** you get into the plot routines. See *Section 14* for more information. Only complex plane plots are enabled for this version of CR.

F6

Skip Flag. By pressing **F6** an 'x' is placed between the version number and the date in the header for the block being viewed. This flag is recognized by the plot routines and the flagged data will be skipped when averaging multiple blocks for plotting. Repeated pressing of

F6

will remove and replace the 'x'.

An example of the complete CR data set stored in the data cache follows. For viewing, it is divided into two or more screens both vertically and horizontally:

Block: 0095 Total:0095										
CR 0535 98-03-15 09:13:17 12.3v D-D 24.7% 32.2 DegC										
Tx	1 Rx	3 N OUT			SEM's					
.125 Hz	4 Cyc Tx	Curr	SP in millivolts							
Contact resistance in ohms										
1	Re	72.140m	-41.1	0.0	0050	.09	0.23	.000u		
2	Ex	1 72.317m	.0	9.488	0050	.10	2.96	1.23K		
3	Ex	2 72.164m	.0	37.71	0050	.09	0.12	690.1		
4	Ex	3 72.387m	.0	94.57	0050	.10	-0.56	1.02K		
5	Ex	4 72.098m	.0	188.4	0050	.09	-1.78	2.27K		
6	Ex	5 72.353m	.0	330.8	0050	.09	-3.56	1.17K		
7	Ex	6 72.425m	.0	529.9	0050	.10	-5.92	1.63K		
Harmonics 1 3 5 7 9										
1	1.0000	-41.1	980.37m	-119.4	946.41m	-187.5	904.10m	-242.7	858.76m	-283.2
2	72.316m	.0	72.318m	.0	72.316m	.0	72.312	.0	72.299m	.0
3	72.163m	.0	72.164m	.0	72.164m	.0	72.163	.0	72.162m	.0
4	72.387m	.0	72.388m	.0	72.385m	.0	72.375	.0	72.384m	.0
5	72.098m	.0	72.096m	.0	72.098m	.0	72.089	.0	72.095m	.0
6	72.353m	.0	72.353m	.0	72.349m	.0	72.352	.0	72.353m	.0
7	72.425m	.0	72.423m	.0	72.423m	.0	72.420	.0	72.423m	.0

NOTES:

1. Channel 1, the reference channel, has had all magnitudes normalized to the fundamental magnitude, and the phase is the raw decalibrated phase for both the run-time and the harmonics portion of the data block.
2. The phase recorded for all non-reference channels (channels 2 through 7 in this example) will be the **3-point decoupled phases** in the top part of the data set example, or the run-time screen, which is the portion that is displayed when not in data cache mode; and will be the raw decalibrated phases for the bottom part of the display, which is the harmonic listing.
3. The CR program is the only program that calculates and uses 3-Point decoupled phase for the run-time screen. The phase information that is stored in the top portion of the data set is always the 3-point decoupled phase, regardless of what is displayed real-time, and the raw decalibrated phases are stored with the harmonic data.

10.4 A NOTE ON PHASE

The **CR/HACSAMT** program is an absolute phase program - that is, the program measures the absolute phase shift between the transmitted signal and the received signal. For normal operations at low frequencies, the real-time phase shift should be around -100 to -200 milliradians. If the phase is closer to π radians (3142 mr) then you have some wires reversed. You can get rid of the π radians of phase shift by either reversing the transmitter wires at the transmitter, or reversing the leads going into the receiver. For multi-channel receivers, it is easiest to make the change at the transmitter, and then maintain the same polarity throughout the survey.

CAUTION

The sign of the calculated phase has been changed to be consistent with all of the absolute phase programs. The original versions of the CR program produced positive phase values for traditional "positive IP". However, an artificial sign change was implemented to do this. Since the CR program is now used for **CSAMT**, **FEM** and **MMR**, as well as **CR**, the sign of the phase had to be made consistent with other programs. Positive IP responses will now have a negative phase value, just like the **RPIP** program. Please contact Zonge Engineering if this causes problems with your in-house data reduction programs.

10.5 A NOTE ON SCALING

The following convention is used for all measured and calculated parameters:

Voltage (magnitudes)	displayed in volts.
Current	displayed in amperes.
Phase	displayed in milliradians.
Apparent resistivity	displayed in ohm-meters.
Dipole spacings	displayed in meters.
SP	displayed in millivolts
SEM	displayed in milliradians

If scaling is necessary on these values, the following labels are appended to the end of the number string:

- M - Mega units
- K - Kilo units
- M - milli units
- u - micro units

10.6 3-POINT DECOUPLING

When operating in low resistivity environments with large dipole spacings, as is common with dipole-dipole or pole-dipole surveys, electromagnetic coupling is often an overwhelming factor in IP measurements. The Complex Resistivity (CR) program provides for automatic removal of electromagnetic effects by using a 3-Point decoupling algorithm, which assumes that the IP effect at very low frequencies is relatively independent of frequency. This routine works well in moderately coupled environments. For extreme coupling environments (e.g., 10 ohm-meter ground and using 300 m dipoles), we recommend that full frequency referenced CR be used to permit more precise coupling removal.

Please note that 3-point decoupling values are easily contaminated by noise. The operator may

want to have the raw phase displayed during run-time. By pressing  when **RAWφ** is displayed above the key, the default real-time display will be changed to the raw phase. The

operator can change between 3-point and raw phase by repeatedly pressing .

The formula used for 3-point decoupling is as follows:

$$\phi_{3pt} = 1.875\phi_1 - 1.25\phi_3 + 0.375\phi_5$$

ϕ_1 = phase at the fundamental frequency

ϕ_3 = phase at the third harmonic

ϕ_5 = phase at the fifth harmonic

10.7 SAMPLE DATA BLOCKS

SHOWING DIFFERENCE BETWEEN REFERENCE AND NON-REFERENCE (HARMONIC RP/IP) OPERATION

0005
 CR 0535 98-11-03 14:44:02 12.6v D-D
 OPER 1 TX ID 1 A-SP 100 Sh 0.100
 JOB 89001 LINE 1.0 N SPREAD 1
 1 DiffAmp Notch+60,3-50,3 S/N 185 Passed 1.00192
 2 DiffAmp Notch+60,3-50,3 S/N 177 Passed 0.99835
 3 DiffAmp Notch+60,3-50,3 S/N 61 Passed 0.99921
 4 DiffAmp Notch+60,3-50,3 S/N 57 Passed 1.00329
 5 DiffAmp Notch+60,3-50,3 S/N 60 Passed 0.99876
 6 DiffAmp Notch+60,3-50,3 S/N 66 Passed 0.99586

0006
 CR 0528 98-11-03 14:45:31 12.7v D-D
 Tx 1 Rx 3 N OUT
 .125 Hz 4 Cyc Tx Curr 1.00
 1 Ex 1 268.00m -2.4 396.8 0300 .11 2.96 1.23K
 2 Ex 2 268.62m -2.4 1.591K 0300 .11 0.12 690.1
 3 Ex 3 268.48m -2.4 3.975K 0300 .11 -0.56 1.02K
 4 Ex 4 268.28m -2.4 7.943K 0300 .11 -1.78 2.27K
 5 Ex 5 268.13m -2.4 13.89K 0300 .11 -3.56 1.17K
 6 Ex 6 268.47m -2.5 22.26K 0300 .11 -5.92 1.63K
 Harmonics 1 3 5 7 9
 1 268.00m -40.7 262.85m -119.1 253.69m -186.8 242.55m -241.6 230.60m -282.4
 2 268.62m -40.8 263.46m -119.2 254.28m -186.8 243.16m -241.4 231.14m -282.5
 3 268.48m -40.7 263.33m -119.0 254.19m -186.6 243.01m -241.0 231.03m -282.1
 4 268.28m -40.8 263.13m -119.1 253.99m -186.8 242.83m -241.4 230.82m -282.4
 5 268.13m -40.8 262.96m -119.2 253.81m -186.8 242.68m -241.4 230.70m -282.3
 6 268.47m -40.8 263.32m -119.1 254.15m -186.7 243.00m -241.5 231.02m -282.6

0007
 CR 0535 98-11-03 14:51:17 12.6v D-D
 Tx 1 Rx 3 N OUT
 .125 Hz 5 Cyc Tx Curr 2.10
 1 Re 268.04m -40.9 188.9 0300 .03 0.23 .000u
 2 Ex 1 268.64m .0 188.9 0300 .02 2.96 1.23K
 3 Ex 2 268.49m .1 755.3 0300 .01 0.12 690.1
 4 Ex 3 268.29m -.0 1.887K 0300 .02 -0.56 1.02K
 5 Ex 4 268.15m -.1 3.771K 0300 .02 -1.78 2.27K
 6 Ex 5 268.50m -.0 6.609K 0300 .02 -3.56 1.17K
 7 Ex 6 268.21m -.1 10.56K 0300 .02 -5.92 1.63K
 Harmonics 1 3 5 7 9
 1 1.0000 -40.9 980.89m -118.9 946.80m -186.8 904.33m -241.7 860.34m -282.6
 2 268.64m .0 268.64m .0 268.66m -.1 268.75m -.1 268.66m .1
 3 268.49m -.00 268.51m -.1 268.54m -.3 268.59m -.4 268.56m -.3
 4 268.29m .0 268.30m .0 268.33m -.1 268.38m -.1 268.27m .0
 5 268.15m -.00 268.15m .1 268.14m -.00 268.19m -.1 268.14m -.0
 6 268.50m .0 268.51m .0 268.52m -.1 268.57m -.0 268.53m .1
 7 268.21m .0 268.17m .1 268.07m .0 268.05m -.1 267.82m .1

These data were acquired using an RC network and a constant current laboratory transmitter. The RC network is as follows:

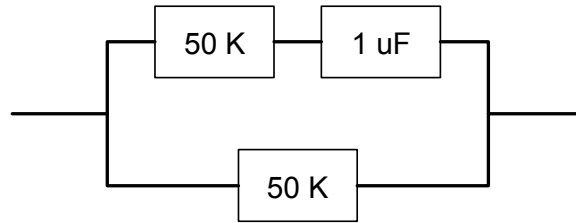

Block 0005 is the program header and is written to the data cache only when the operator goes between Menu 2 and 3.

Block 0006 is the main data block and is written at the end of each data acquisition cycle, when



is pressed in answer to the instruction: "**CONTINUE to save, RESET to discard**". This data block is an example of non-reference CR or harmonic RP/IP.

Block 0007 contains the referenced CR data and is of the same form as that shown previously.

10.8 NOTES ON FIELD CONFIGURATIONS

When running multiple channel receiver systems, you must be very careful to avoid common mode problems. Common mode effects are caused by lack of a reference voltage or level (floating ground), or a reference level that exceeds common mode limits of the input amplifiers.

Common mode levels for the standard configuration of the GDP-32^{II} are ± 10 volts. With external isolation amplifiers, this level can be extended to several thousand volts, but in exchange one has to contend with higher noise and a lower overall frequency response.

The best configuration that we have found is to install a **REFERENCE ELECTRODE** (standard copper/copper-sulfate electrode or equivalent), connected to analog ground (**COM** on the analog side-panel) and the case ground (**CASE GND** on the side panel), positioned next to the receiver and at least one meter distant from the nearest receiving electrode.

Another consideration is protection from static discharge and nearby lightning strokes. This protection is maximized by connecting the case ground to the **REFERENCE ELECTRODE** as well.

Additional protection in lightning-prone areas can be afforded by using a galvanized iron plate (or equivalent) as a **REFERENCE ELECTRODE**. This plate should be buried close to the receiver in a hole that has been well watered and the soil mixed to make good mud contact with the plate. Typical size for the plate would be 30 by 30 cm.

The figures at the end of this chapter provide examples of receiver connections using the **REFERENCE ELECTRODE** or **REFERENCE POT** connected to both analog ground (**COM**) and case ground (**CASE GND**).

We have found that for most environments, the best noise rejection is obtained by connecting the analog ground (**COM**) to the case ground (**CASE GND**) on the analog I/O side panel.

ADDITIONAL NOTE ON MAGNETIC COILS FOR HACSAMT AND OTHER MEASURING TECHNIQUES USING MAGNETIC COILS:

If the magnetic coil being used has a differential (3-wire) output, connect the two signal wires to the red and black input terminals, and the ground wire to **COM** on the analog side-panel.

If the magnetic coil has a single-ended (2 wire) output, connect the signal wire to the red input and connect the ground wire (or shield, if it is a coaxial cable) to the black input.

10.9 SAMPLE MENUS FOR "LABROX" OPTION

MENU 1:

Shunt is the value of the current measuring resistor (in the decade resistance box - see the diagrams at the end of this chapter) that is adjusted to be close to the resistance of the rock sample being measured. This parameter can also be

entered in Menu 4 under **L/A** **F5**.

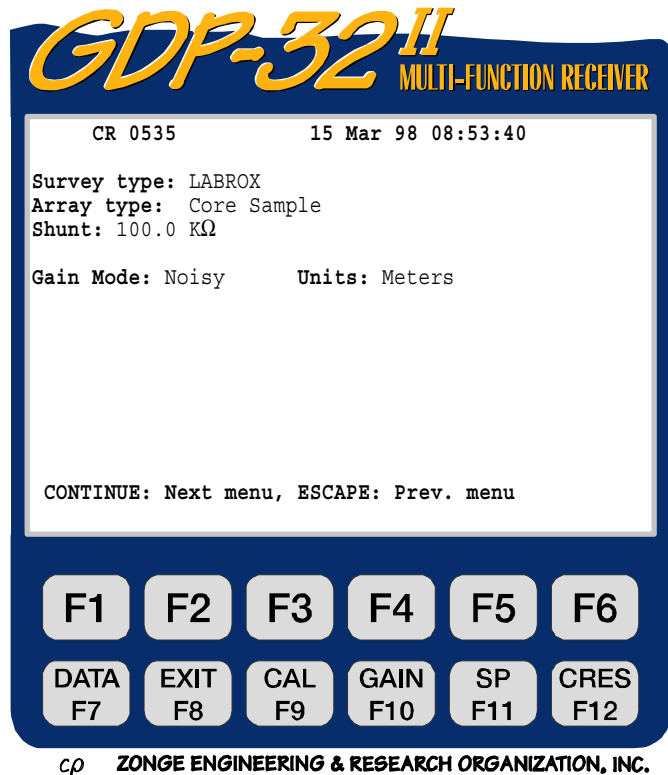

MENU 2:

This is the same menu as in the normal CR option.

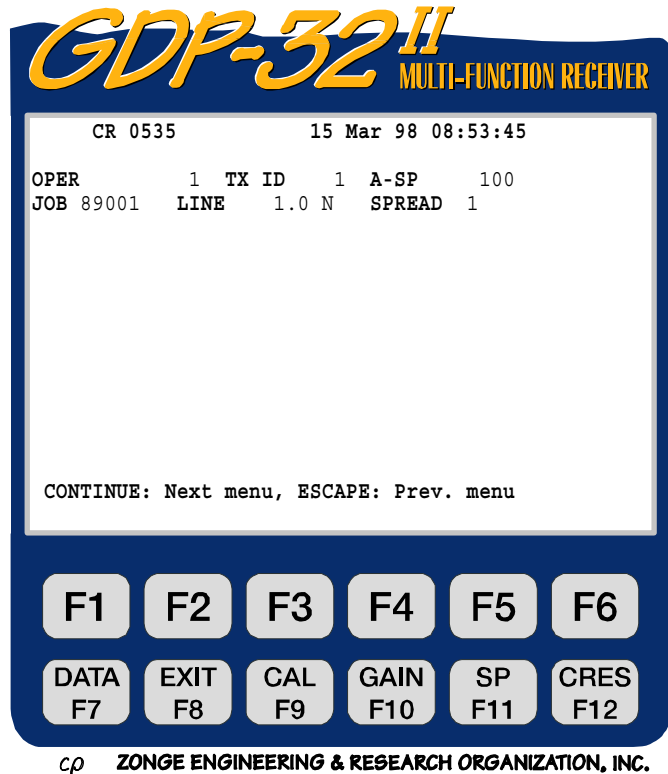

MENU 3:

Channels 1 and 2 are automatically set as shown. Channel 1 (Ex) is the voltage across the rock sample, Channel 2 (Ref) is the voltage across the decade resistance box or shunt resistor.

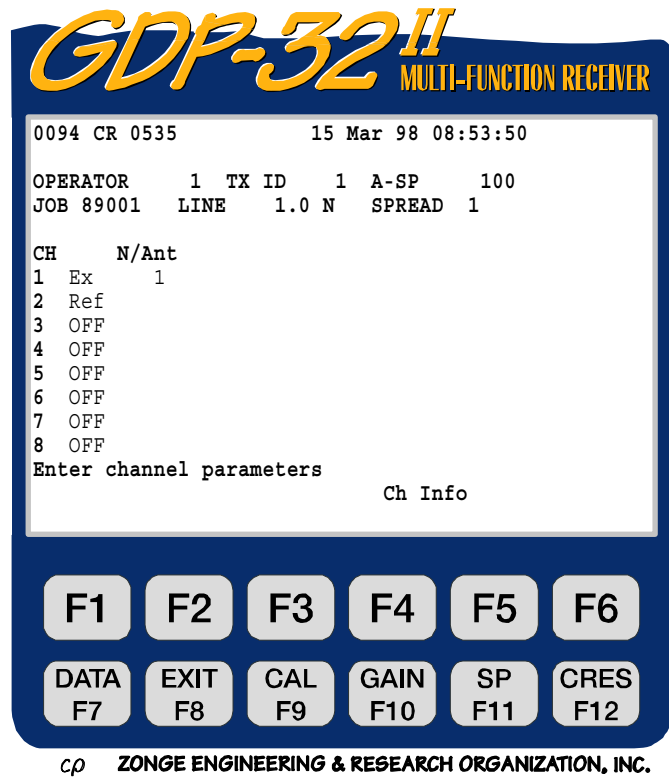

MENU 4

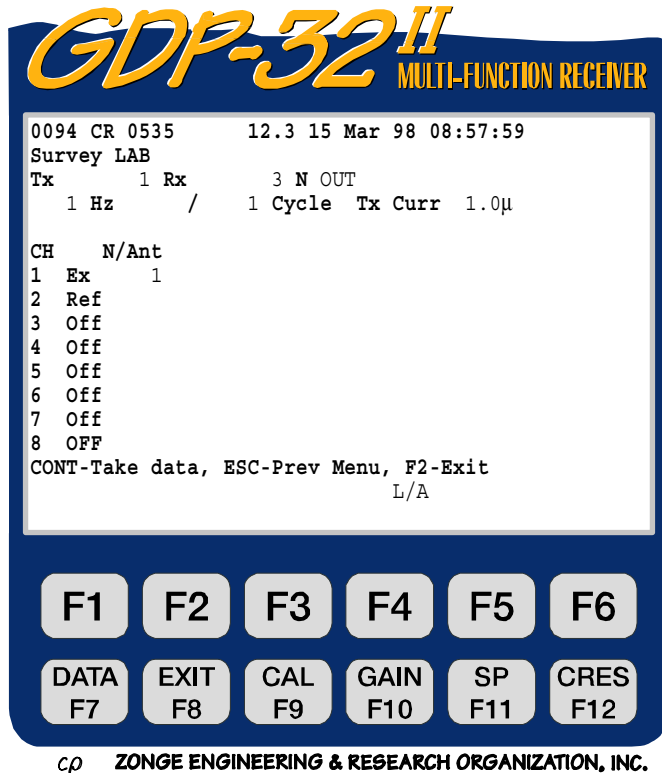

← We have selected the **LABROX** (core sample) option

The differences between this menu and the standard CR menu are the **F5** key that is now labeled **L/A** and the Tx Curr that is now in microamperes. The current is automatically calculated by the **Ref** channel and displayed in microamperes.

L/A. By pressing **F5** the following menu appears:

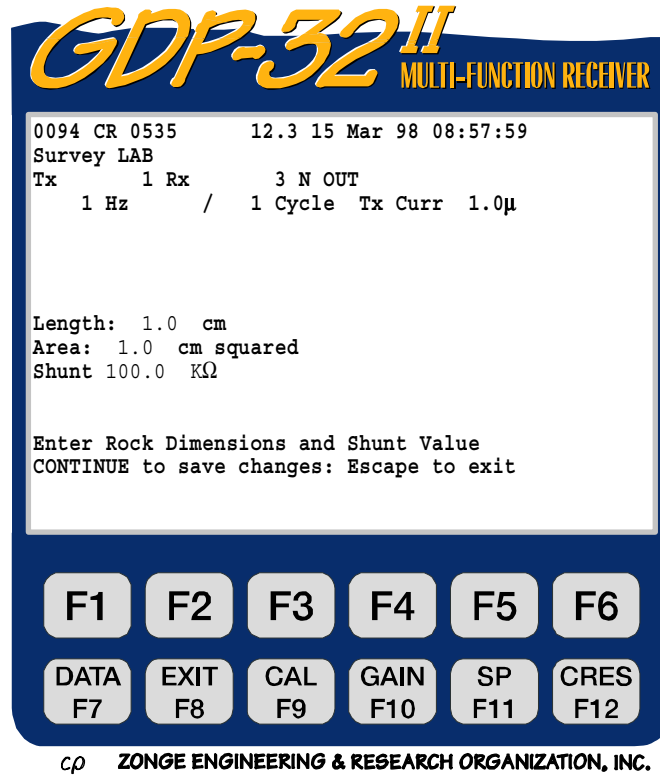

Here the length and cross-sectional area of the rock sample are input to the system for calculation of the resistivity of the sample. The shunt is the value of the current measuring resistor (typically a decade resistance box) that is set equal to the resistance of the rock sample.

Use the **CRes** function key to get an approximate value for the rock resistance for setting the shunt resistor.

10.10 SAMPLE MENUS FOR "HACSAMT" OPTION

MENU 1:

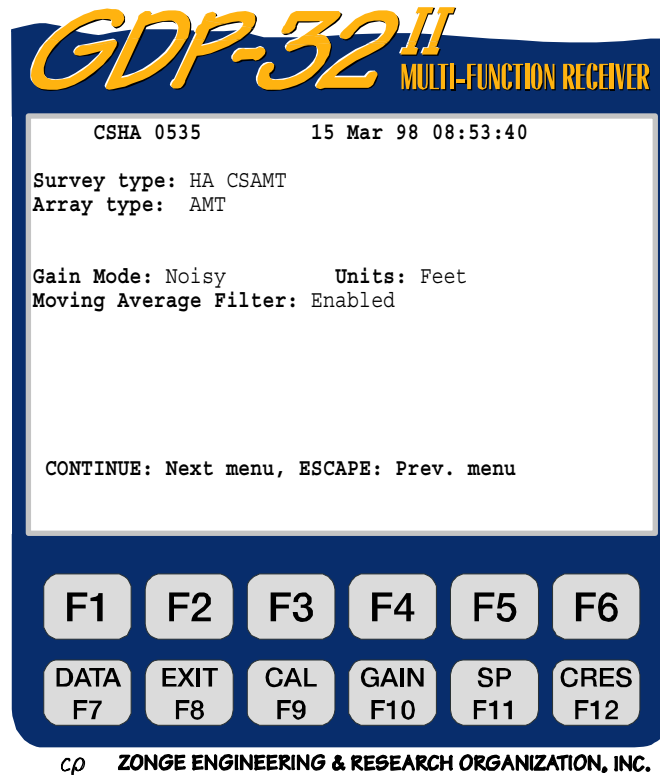

MENU 2:

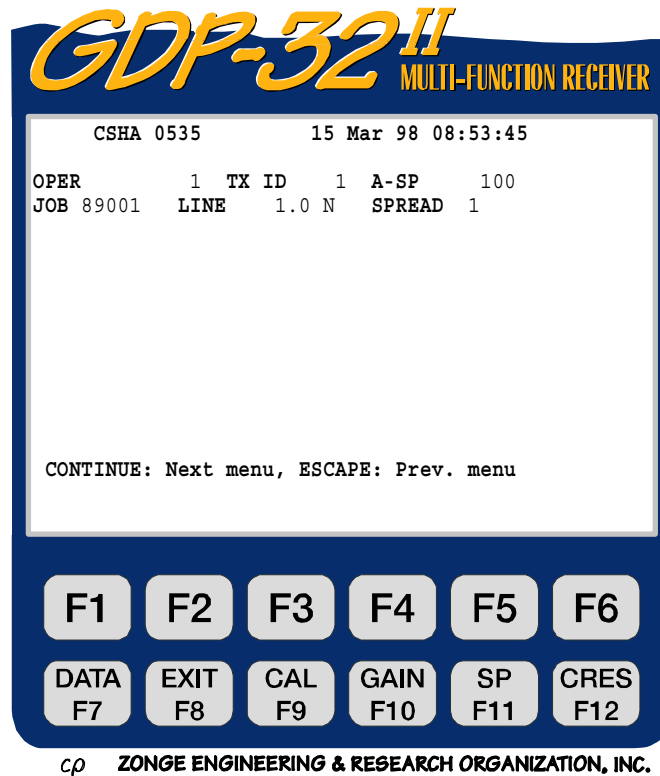

This is the same menu as in the normal CR option.

MENU 3:

The following example is the setup for a 6 E-field and 1 H-field harmonic CSAMT survey

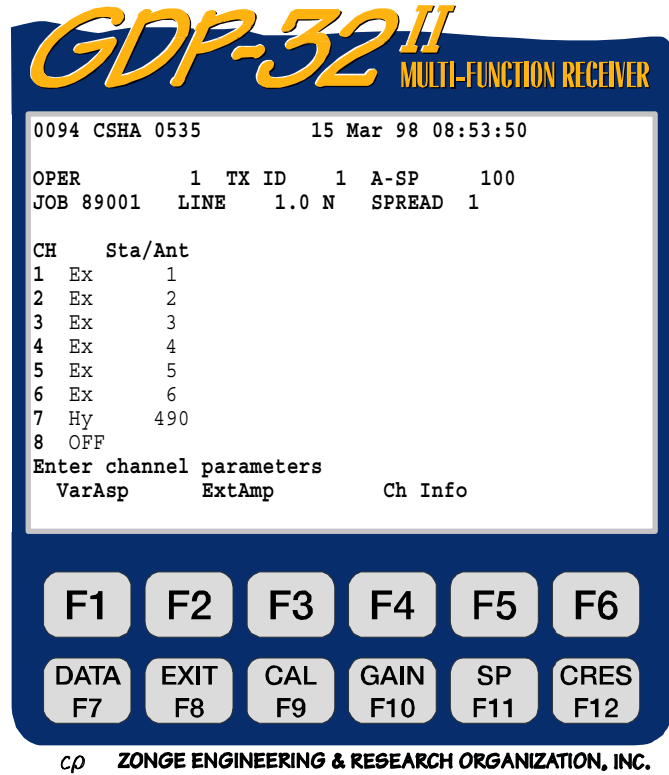

MENU 4

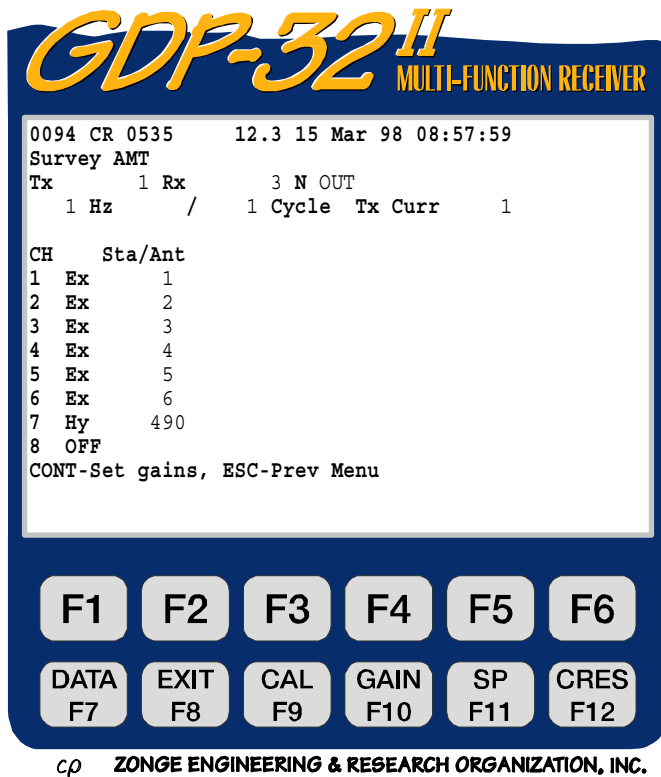

← We have selected the harmonic CSAMT option

← Coil number 490

For Menus 3 and 4, the operation is just as it is for the standard CSAMT survey type. Refer to the CSAMT program chapter for more information.

10.11 FIELD CONFIGURATIONS

GDP SETUP: RESISTIVITY, TDIP, RPIP, NRCR

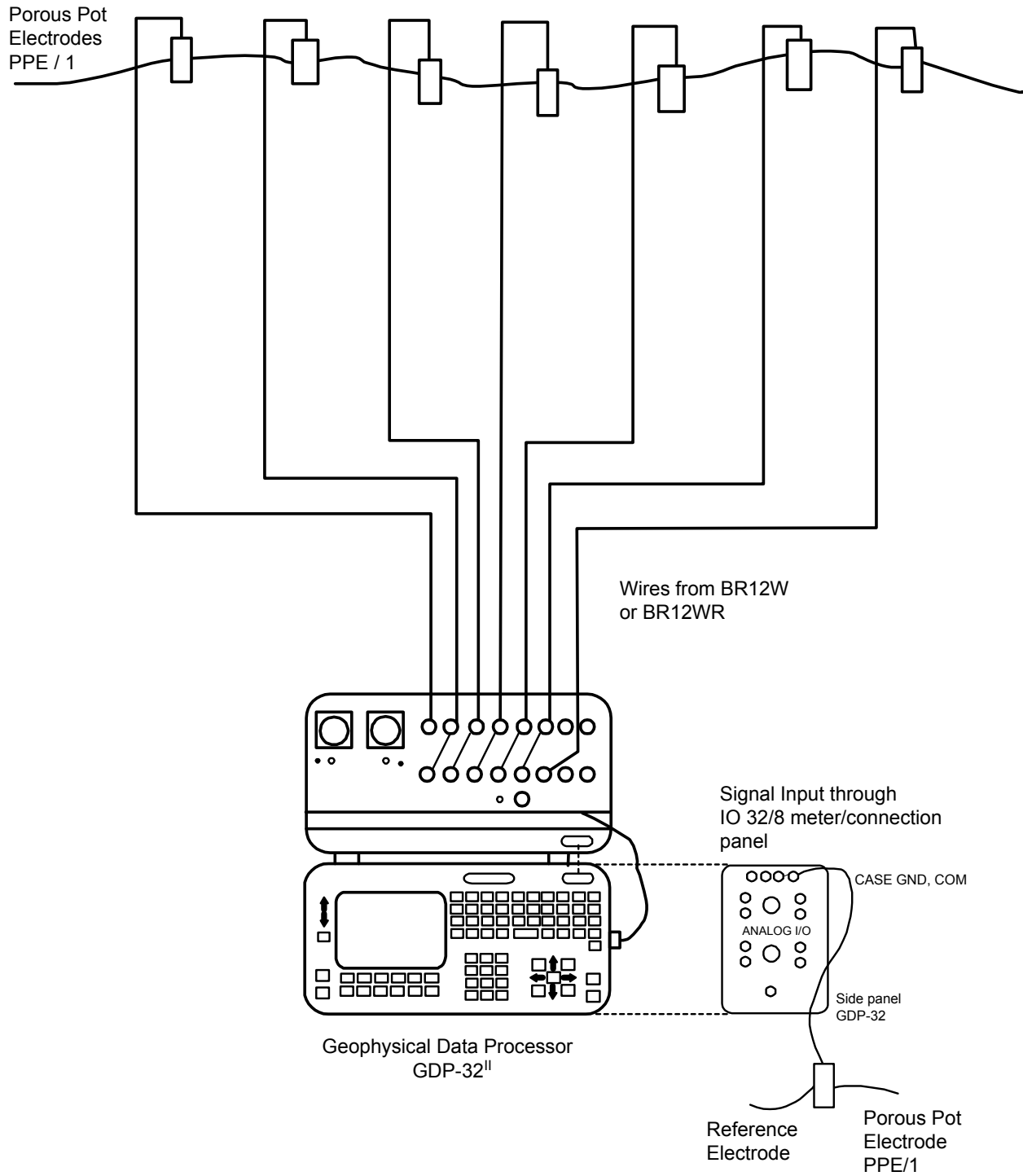

GDP SETUP WITH ROLL-ALONG CABLE: RESISTIVITY, TDIP, RPDP, NRCR

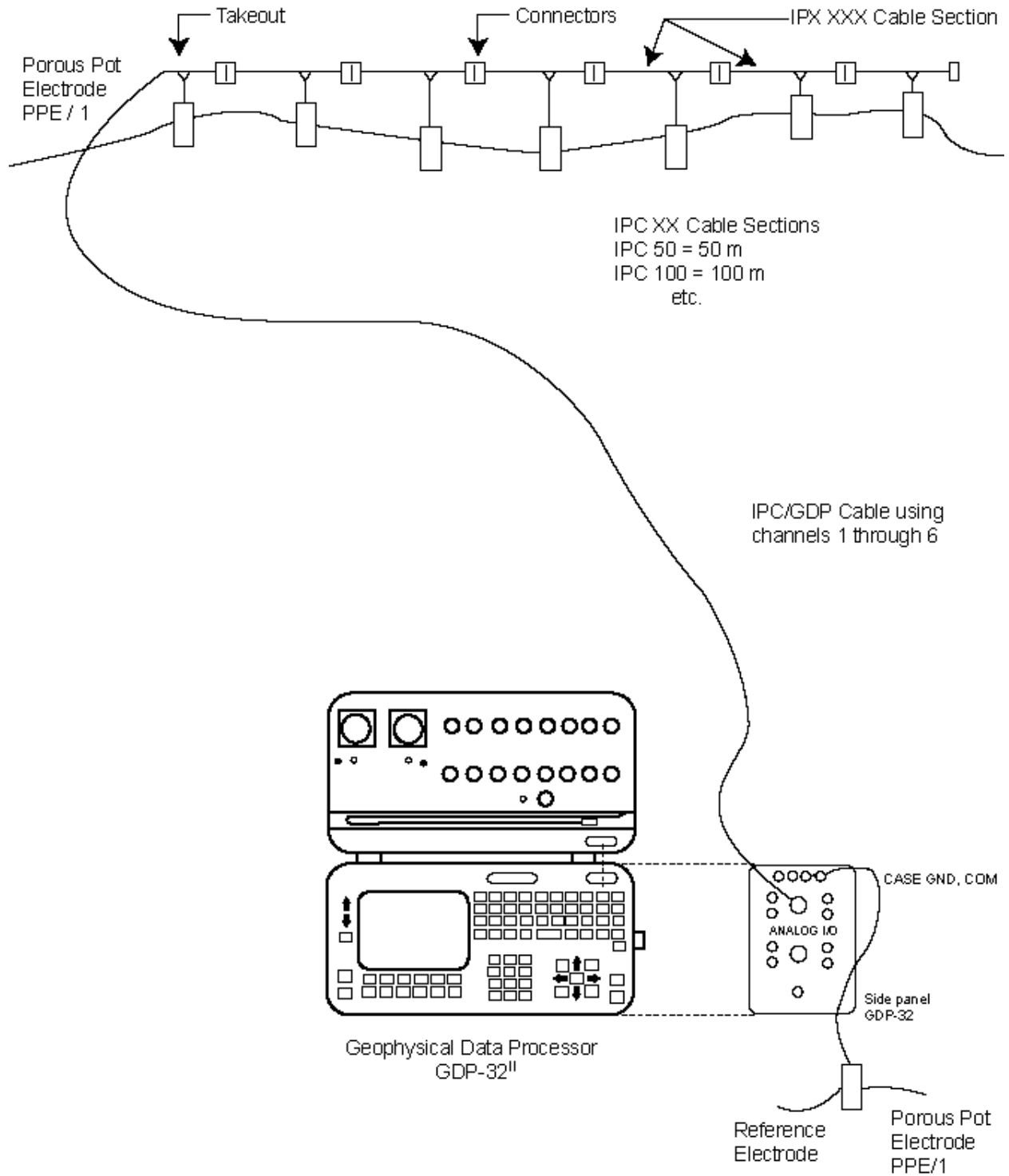

TRANSMITTER SETUP: TDIP, RPIP, NON-REFERENCE CR

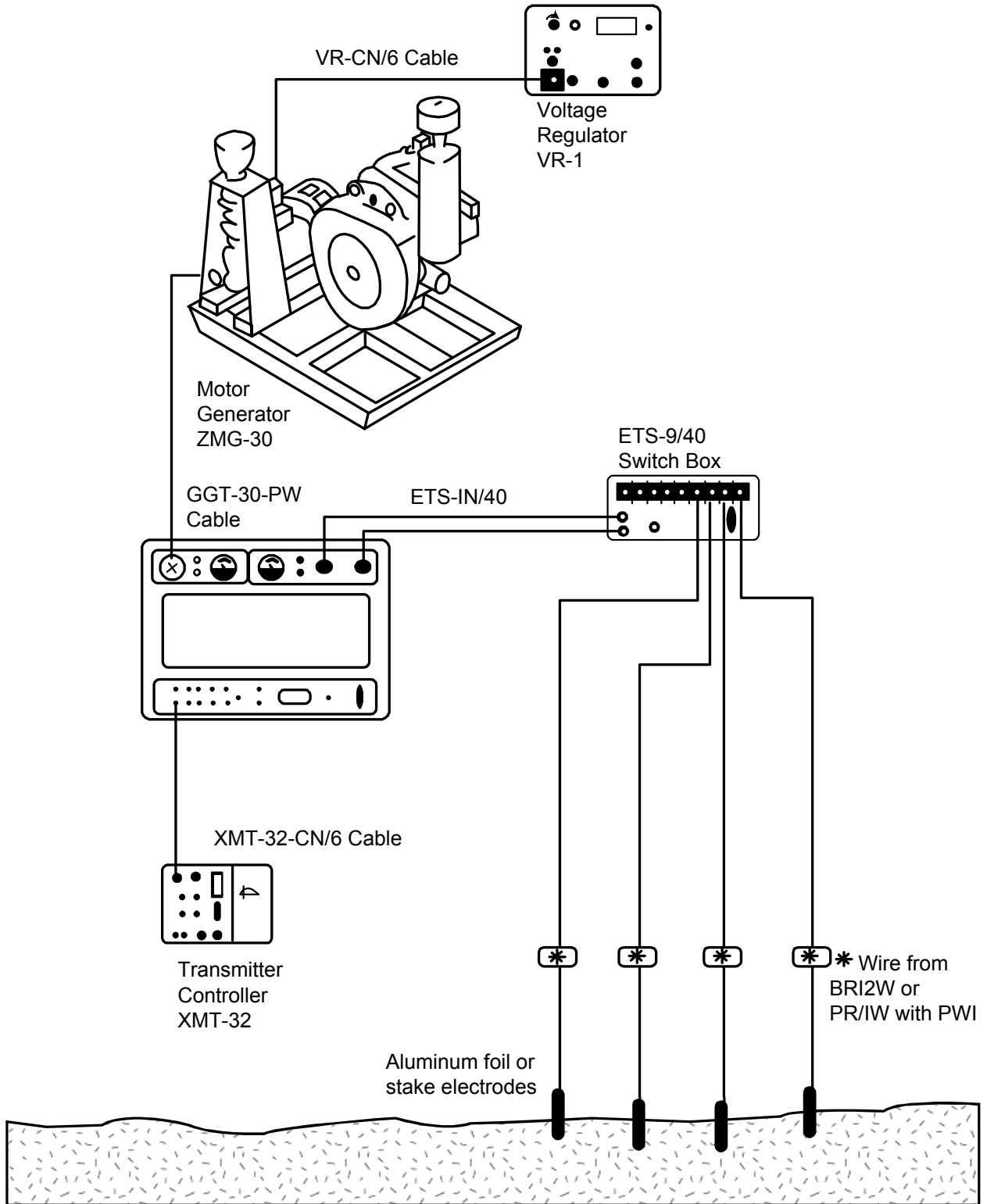

TRANSMITTER SETUP WITH CURRENT REFERENCE

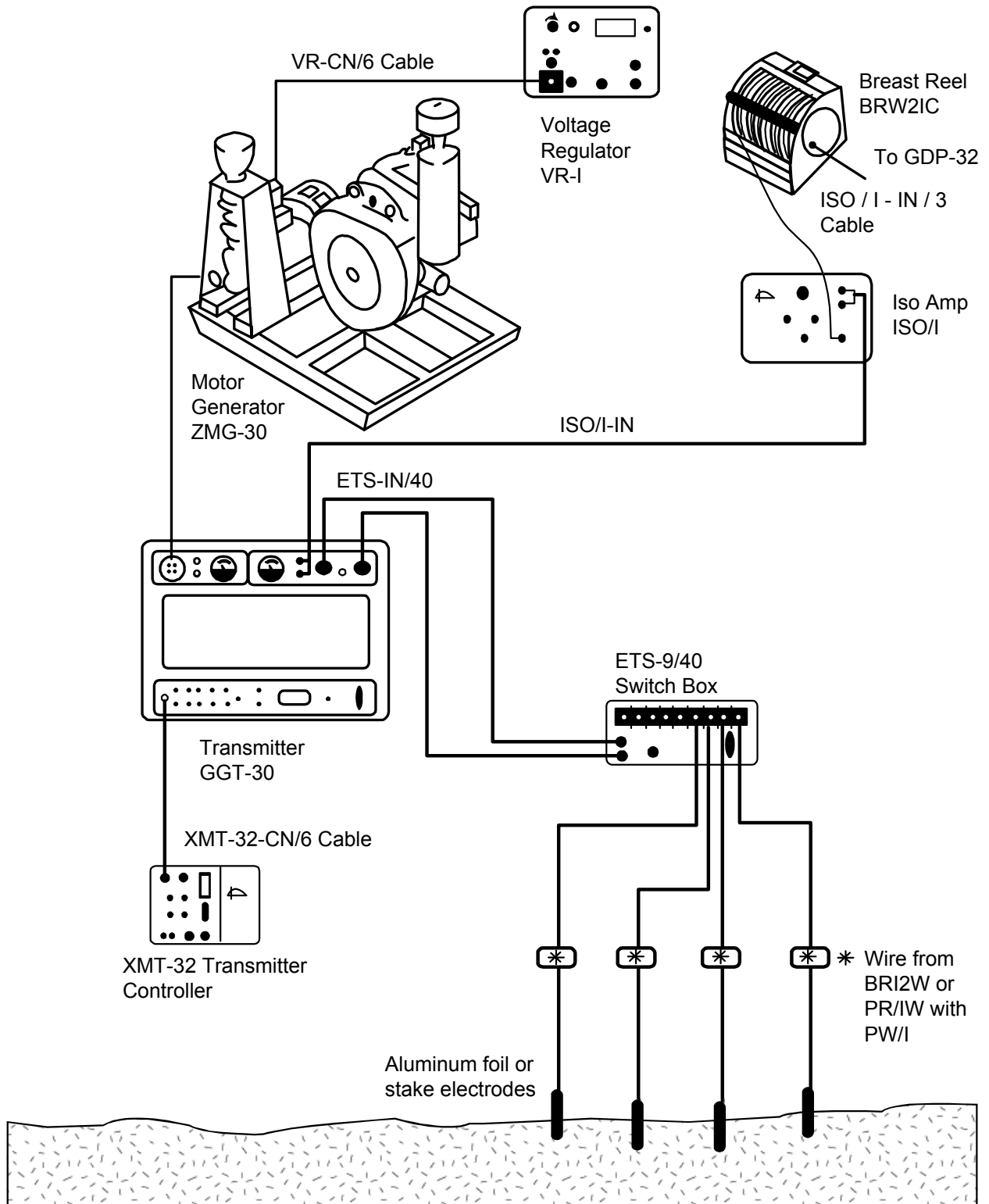

COMPLEX RESISTIVITY RECEIVER SETUP WITH CURRENT REFERENCE

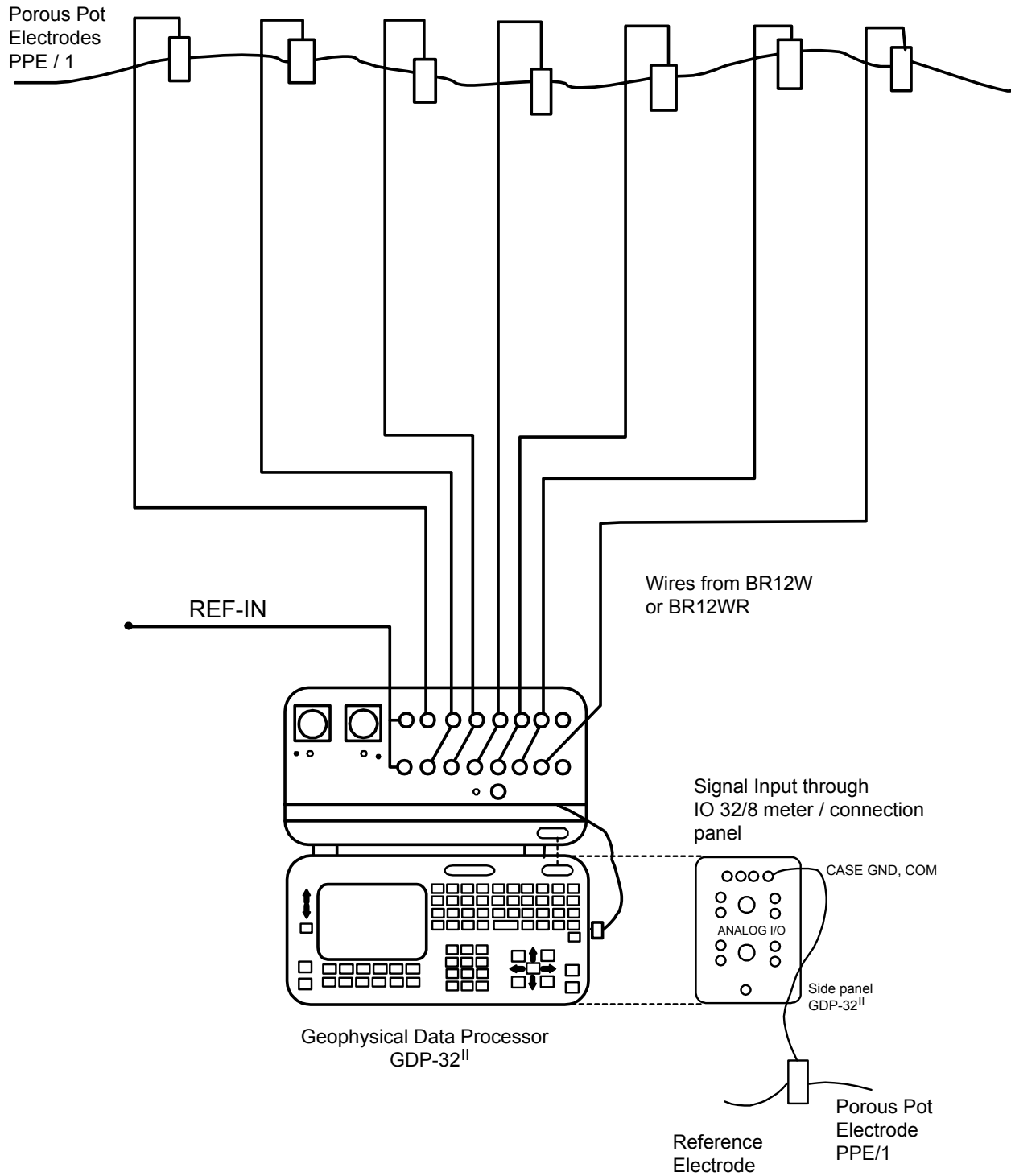

FULL REFERENCE CALIBRATION

CRIP Full Reference Calibration Wiring Diagram

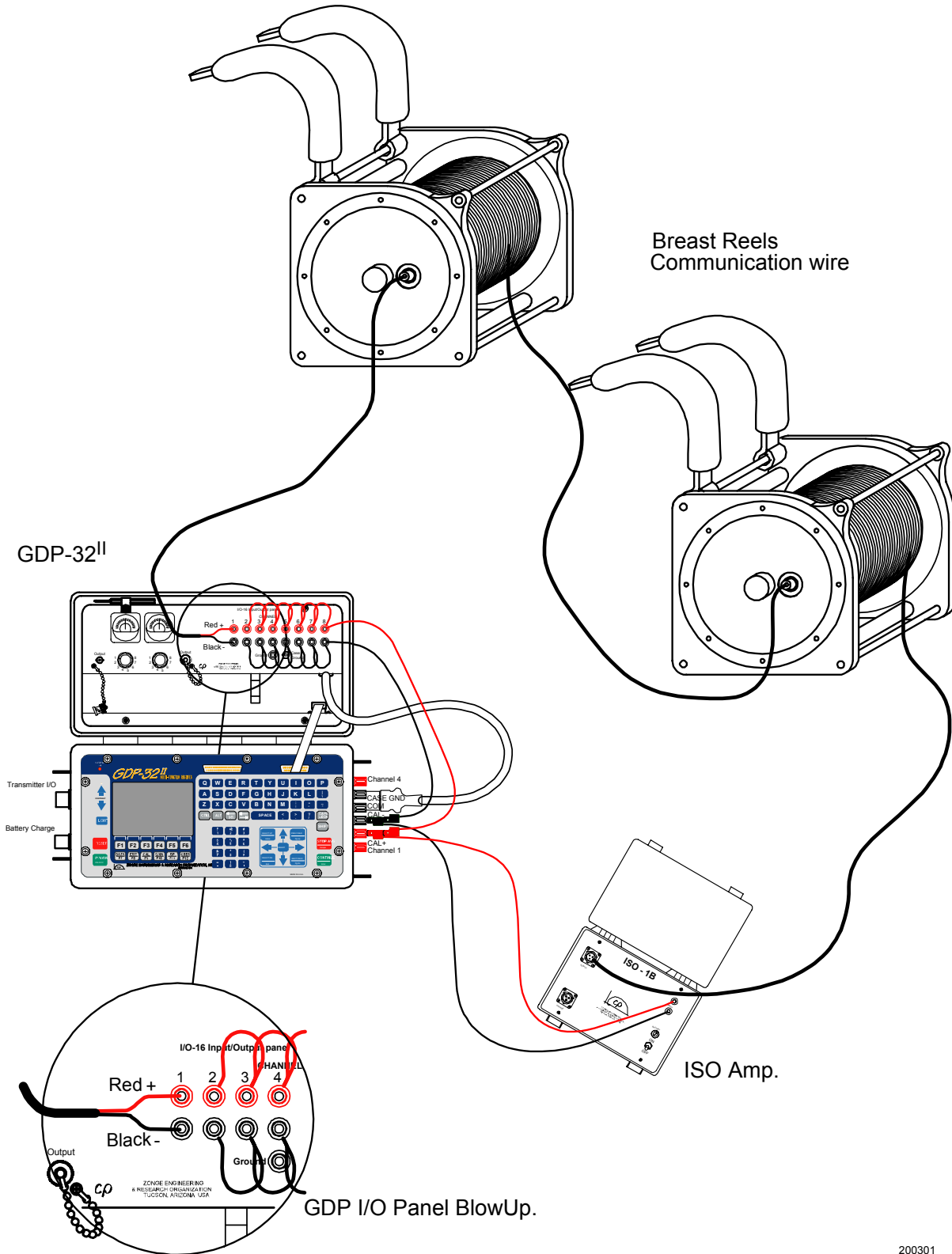

200301

LABORATORY ROCK MEASUREMENT SETUP

LABORATORY ROCK MEASUREMENT SETUP

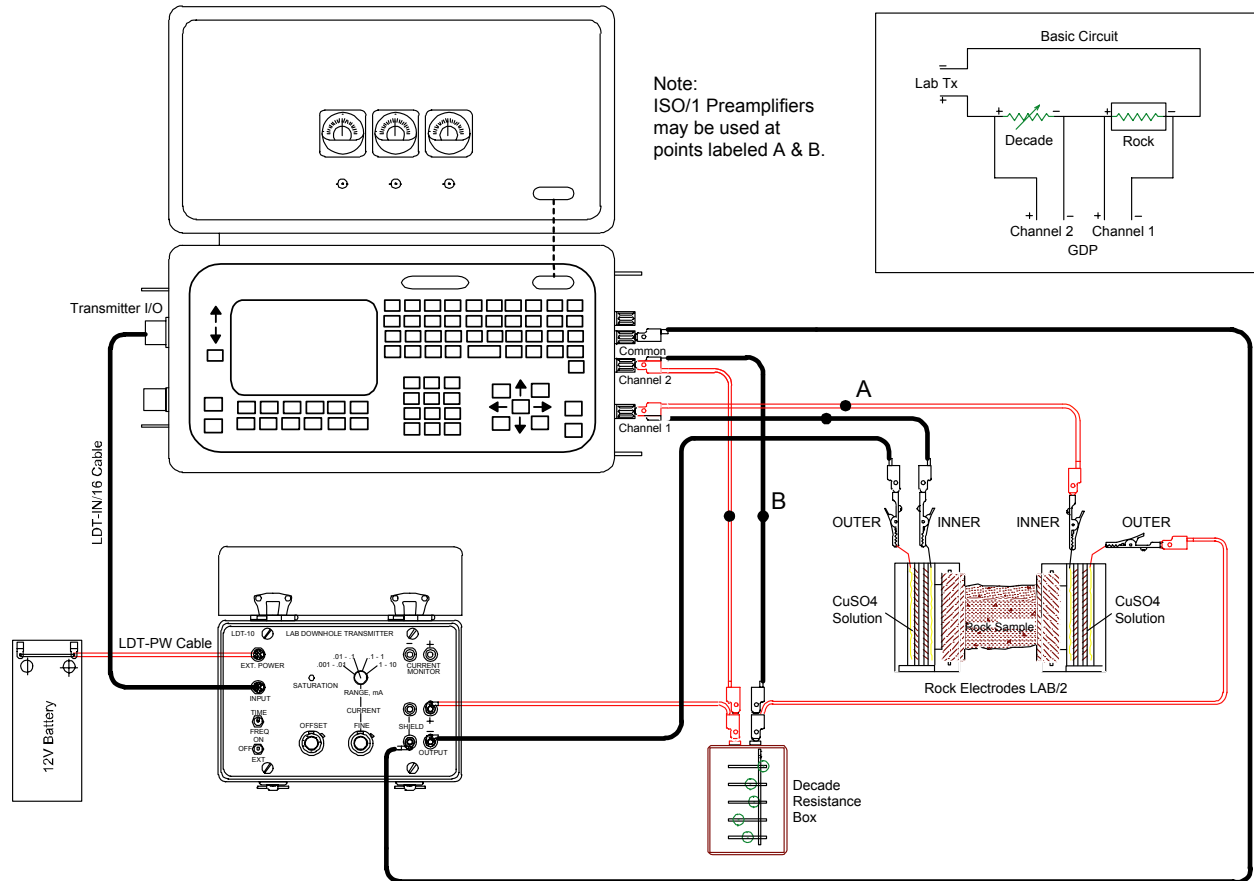

ALTERNATE LABORATORY ROCK MEASUREMENT SETUP

ALTERNATE LABORATORY ROCK MEASUREMENT SETUP

